

7" Under-the-Counter LCD / DVD FDM-0700A

Operating Manual



 **Polaroid**®

Table of Contents

Table of Contents	2
Important Safety Instruction	3
FCC Notice	5
Characteristic Features	6
Disc Information	7
Front Panel	8
Rear Panel and Display Panel	10
Remote Control	11
Preparation	11
Using Of Remote Control	11
System Connections	13
Connecting To External AV Signal Source	15
Connecting To TV Signal Input Source	15
Connecting To Antenna	16
Connecting To the Power Adapter	17
Radio Function	18
TV Function	19
AV Function	23
Play Operation	24
Playback Functions	27
System Setup	29
DVD Setup	29
LCD Setup	31
Installing the Unit in Kitchen	32
Troubleshooting	34
Specifications	35

Important Safety Instructions

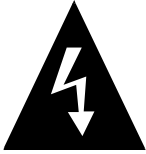

CAUTION

**RISK OF ELECTRIC SHOCK
DO NOT OPEN!**



CAUTION: TO REDUCE THE RISK OF ELECTRIC SHOCK, DO NOT REMOVE COVER (OR BACK). NO USE-SERVICEABLE PARTS INSIDE. REFER SERVICING TO QUALIFIED SERVICE PERSONNEL.



The lightning flash with arrowhead symbol, within an equilateral triangle, is intended to alert the user to the presence of uninsulated "dangerous voltage" within the product's enclosure that may be of sufficient magnitude to constitute a risk of electric to persons.



The exclamation point within an equilateral triangle is intended to alert the user to the presence of important operating and maintenance (servicing) instructions in the literature accompanying the appliance.

WARNING: TO REDUCE THE RISK OF FIRE OR ELECTRIC SHOCK, DO NOT EXPOSE THIS APPLIANCE TO RAIN OF MOISTURE.

POWER SUPPLY:

Connect the supplied adapter to the side of the DVD player in the slot marked "DC 12V IN". Plug the two-prong end of the power cord to an AC100-240V outlet. If you have difficulty inserting the plug, turn it over and reinsert it, if the unit will not be used for a long time, disconnect the plug from the outlet.

NOTE:

Before plugging the power cord into an AC outlet, make sure that all the connections have been made.

CAUTION:

These servicing instructions are for use by qualified service personnel only. To reduce the risk of electric shock, do not perform any servicing other than that contained in the operating instructions unless you are qualified to do so.

Refer to service manual for servicing instructions.

Important Safety Instructions

Note:

1. Read these instructions.
2. Keep these instructions.
3. Heed all warnings.
4. Follow all instructions.
5. Do not use near water.
6. Clean only with dry cloth.
7. Do not block any ventilation openings. Maintain well ventilated conditions around the product. Do not put product on bed, sofa or anything that blocks ventilation. Install in accordance with the manufacturer's instructions.
8. Do not install near any heat sources such as radiators, heat registers, stoves, or other apparatus (including amplifiers) that produce heat.
9. Do not defeat the safety purpose of the polarized or grounding-type plug. A polarized plug has two blades with one wider than the other. A grounding type plug has two blades and a third grounding prong. The wide blade or the third prong is provided for your safety. If the provided plug does not fit into your outlet, consult an electrician for replacement of the obsolete outlet.
10. Protect the power cord from being walked on or pinched particularly at plugs, convenience receptacles, and the point where they exit from the apparatus.
11. Only use attachments/accessories specified by the manufacturer.
12. Use only with the cart, stand, tripod, bracket, or table specified by the manufacturer, or sold with the apparatus. When a cart is used, use caution when moving the cart/apparatus combination to avoid injury from tip-over.
13. Unplug this apparatus during lightning storms or when unused for long periods of time.
14. Refer all servicing to qualified service personnel. Servicing is required when the apparatus has been damaged in any way, such as power-supply cord or plug is damaged, liquid has been spilled or objects have fallen into the apparatus, the apparatus has been exposed to rain or moisture, does not operate normally, or has been dropped.
15. Apparatus shall not be exposed to dripping or splashing and no objects filled with liquids, such as vases, shall be placed on the apparatus.

IMPORTANT FOR LASER PRODUCTS

1. CLASS 1 LASER PRODUCT
2. **DANGER:** Visible laser radiation when open and interlock failed or defeated. Avoid direct exposure to beam.
3. **CAUTION:** Do not open the top cover. There are no user serviceable parts inside the unit. Leave all servicing to qualified service personnel.



Copyright Protection

Unauthorized copying, broadcasting, public performance, and lending of disks are prohibited. This product incorporates copyright protection technology that is protected by method claims of certain U.S. patents and other intellectual property rights owned by Macrovision Corporation and other rights owners. Use of this copyright protection technology must be authorized by Macrovision Corporation, and is intended for home and other limited viewing uses only unless otherwise authorized by Macrovision Corporation. Reverse engineering or disassembly is prohibited.

FCC Notice

Note: This equipment has been tested and found to comply with the limits for a Class B digital device, pursuant to part 15 of the FCC Rules. These limits are designed to provide reasonable protection against harmful interference in a residential installation. This equipment generates, uses and can radiate radio frequency energy and, if not installed and used in accordance with the instructions, may cause harmful interference to radio communications. However, there is no guarantee that interference will not occur in a particular installation. If this equipment does cause harmful interference to radio or television reception, which can be determined by turning the equipment off and on, the user is encouraged to try to correct the interference by one or more of the following measures:

- Reorient or relocate the receiving antenna.
- Increase the separation between the equipment and receiver.
- Connect the equipment into an outlet on a circuit different from that to which the receiver is connected.
- Consult the dealer or an experienced radio/TV technician for help.

Characteristic Features

This product incorporates a DVD player, LCD display, TV receiver and radio function in one system. It is designed for convenient use in the kitchen. Please refer to page 32 for the installation instructions.

Multiple Mode

- DVD
- TV
- Radio
- External Audio & Video Input mode

High Quality Property

Video Screen

Supports normal screen (4:3) and wide screen (16:9) aspect ratios.

AV Input

External Audio, Video input can be connected to most external AV sources.

LCD (Liquid Crystal Display) screen

Color video screen designed with LCD technology clearly shows video data.

Amplifier Function

Built-in 2x2.5w stereo amplifier with left and right speakers.

Switching Power Adapter

Automatically adapts to the voltage required.

Special Functions

Supports Multi-language and Parental-lock features.

Advanced Playing Function

Compatibility

Plays: DVD, CD, CD-R, CD-RW, JPEG and MP3 discs.

On-Screen Display

Displays your choice of English, Spanish or French.

Fast Search Function

Multi-speed, fast forward, fast reverse, slow play and repeat playback.

Zoom Function

Allows the viewer to enlarge in the picture.

Search By Time

Search for a certain time on a disc.

Last Memory Playback

Continues playback from a stopped point as long as power is applied to the DVD Player.

TV Functions



- Clear TV signal reception.
- Search for TV channels automatically.
- Automatically memorize the channels.

Radio Functions

- Clear AM/FM signal reception.
- Search for radio stations automatically.
- Store radio stations easily.
- Search for radio stations in high or low frequency range.

Disc Information

Disc Formats Supported By This Player

	DISC LOGO	DIAMETER	PLAYBACK TIME/ PLAYABLE SIDES
DVD		12cm	133 min (SS-SL)
			242 min (SS-DL)
			266 min (SS-SL)
			484 min (SS-DL)
		8cm	41 min (SS-SL)
			75 min (SS-DL)
			82 min (DS-SL)
			150 min (DS-DL)
CD		12cm	74 min
		8cm	20 min
MP3		12cm	600 min

The disc maker specifies the operation of some DVD discs. Please refer to the instruction manual with the disc.

Care of Discs

Do not touch the playing surface of the disc.

Do not stick paper or labels on the disc.



Cleaning of Discs

If a disc has fingerprints or dust on it, lightly wipe the disc with soft cloth from the center of the disc outward.



Storage of Discs

Do not expose discs to direct sunlight or excessive temperatures.

Never use record cleaning sprays, or any other solvents to clean your discs.

Front Panel

Front Panel Drawing

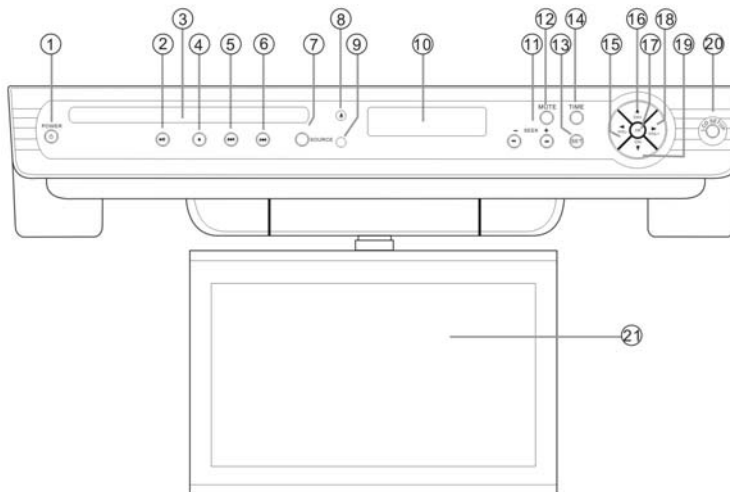

1. POWER button

Press to enter or exit the STANDBY mode.

2. PLAY/PAUSE button

Press to start or pause playback under DVD mode.

3. Disc Tray

Used to load disc.

4. STOP button

Press to stop playback under DVD mode.

5. ►

Press to go to the next track under DVD mode.

6. ◀

Under DVD mode, press once to go to beginning of the current track/chapter.

Press twice to go to the previous track/chapter.

7. SOURCE button

Press to shift among DVD, TV,AV,FM and AM mode.

8. EJECT button

Press to open or close the disc tray.

9. Remote Sensor

Receives remote control signal for operation.

10. Display panel

Displays the time, status, radio frequency and radio station number. When adjusting volume, the VOL and volume level will be displayed on the display panel for several seconds.

Front Panel

11. SEEK +/- button

Under radio mode, press once to fine tune frequency backward or forward. Press for about 1.5 seconds to search radio stations backward or forward automatically.

Under DVD mode, press to activate fast backward or forward playback.

12. MUTE button

Press to turn the speaker output on or off. The corresponding information will be displayed on the display panel.

13. SET button

Press to enter and exit from the timer setup menu. Press to memorize the station under AM/FM status.

14. TIME button

Press it once to display the time on the display panel. In standby status, the time is still displayed on the panel.

Press it again to set the time on the display panel. Use the ◀ ▶ buttons to select the editing position of hour or minute, and then use the ▲ ▼ buttons to adjust the value of the hour or minute upward and downward.

15. ◀

Press to select items in the setup menu. Or press to decrease the volume. Or press to decrease the value in the picture setup menu.

16. ▲

Press to select items in the setup menu. Press to select channels or radio stations forward under TV or radio mode. Press to adjust the value upward when setting the time on the display panel.

17. OK button

Press to confirm selections in setup menu.

18. ▶

Press to select items in the setup menu. Press to increase the volume. Press to increase the value in the picture setup menu.

19. ▼

Press to select items in the setup menu. Press to select the channels or radio stations backward under TV or radio mode.

Press to adjust the value downward when setting the time on the display panel.

20. TV/LCD SETUP button

Press to enter the TV/LCD setup menu.

21. LCD screen

Presents a high resolution picture.

Rear Panel and display panel

Rear Panel Drawing

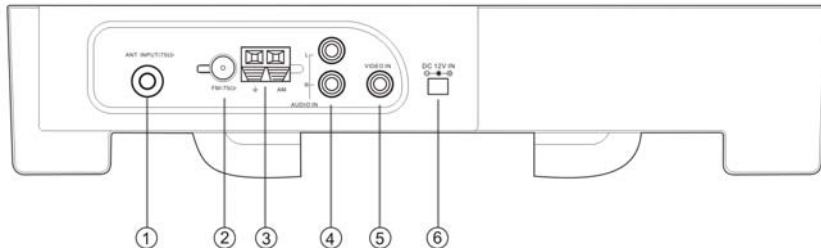

1. ANT INPUT jack

Connected to external antenna to receive the TV program in TV mode.

2. FM 75 Ω coaxial antenna jack

3. AM antenna jack

4. Left/Right AUDIO input jack

Connection for audio input.

5. VIDEO input jack

Connection for video input.

6. Direct current 12V input jack

Display Panel Drawing

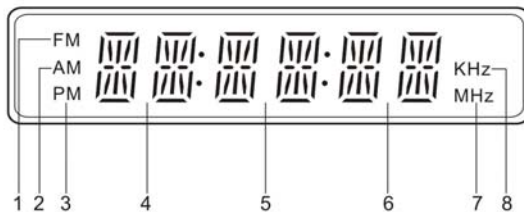

1. FM radio status indicator

2. AM radio status indicator

AM time indicator

3. PM time indicator

4. Hour or character indicators

5. Minute or character indicators

6. Character indicators

7. FM frequency unit of MHz indicator

8. AM frequency unit of KHz indicator

Remote Control

Preparation

Refer to the drawing and remove the empty battery receptacle.

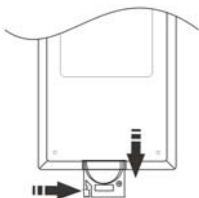

Insert the battery into the receptacle. Make sure the polarity matches the marks inside the component.

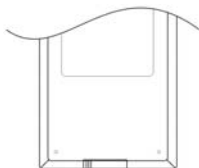

Insert the receptacle into the remote control.

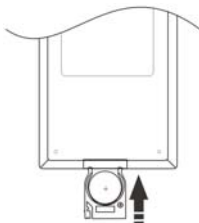

Using Of Remote Control

Point the remote control towards the main unit when operating. The r/c works best at a distance less than 7m and at an angle of up to 60° to the front of the unit. No obstacles may stand in the way between r/c and infrared sensor.

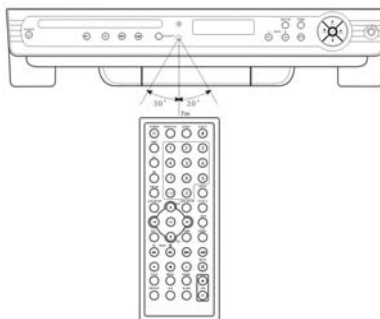

The batteries normally last for about six months. This depends on how often and for what operations the remote control is used.

If the remote control unit fails to work even when it is operated near the player, replace the batteries.

If the r/c is not used for a long period of time, please remove the batteries from the compartment, to prevent damage by leakage.

Remote Control

Remote Control Drawing

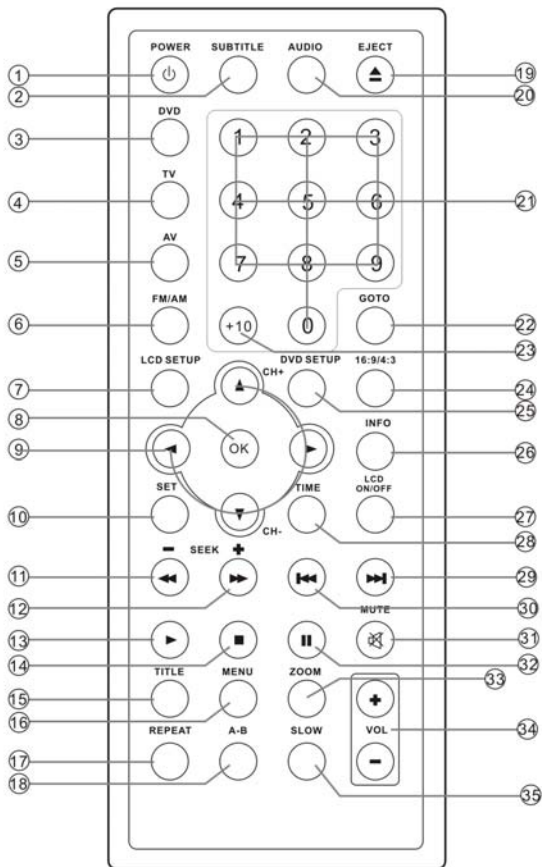

Remote Control

1. POWER button

Press to access to or exit the STANDBY mode.

2. SUBTITLE button

Press to select a subtitle language or to turn subtitles off when a DVD with multi-subtitles is playing.

3. DVD button

Press to enter DVD mode.

4. TV button

Press to enter TV mode.

5. AV button

Press to shift to external AV input mode.

6. FM/AM button

Press to shift to FM/AM signal input mode.

7. TV/LCD SETUP button

Press to enter the TV/LCD SETUP menu.

8. OK button

Press to confirm selections.

9. ◀ ▶ ▲ ▼

Press to select menu items or settings. Press ◀ ▶ buttons to adjust volume. Or press to adjust value in the picture setup menu.

Press ▲ ▼ buttons to select channels or radio stations forward and backward in TV or radio mode. Or press to adjust the value of time when setting time on the display panel.

10. SET button

Press to enter and exit from the timer setup menu. Or Press to memorize the station under AM/FM status.

11. SEEK – button

Under radio mode, press once to fine tune frequency backward. Press for about 1.5 seconds to search radio stations backward automatically. Under DVD mode, press to activate fast backward playback.

12. SEEK + button

Under radio mode, press once to fine tune frequency forward. Press for about 1.5 seconds to search radio stations forward automatically. Under DVD mode, press to activate fast forward playback.

13. PLAY button

Press to start playback under DVD mode.

14. STOP button

Press to stop playback under DVD mode.

15. TITLE button

Press to display titles if present on the disc under DVD mode.

16. MENU button

Press to access the disc menu under DVD mode.

17. REPEAT button

Press to repeat a title, chapter, title or the entire disc.

18. A-B Repeat button

Used to play a section of the DVD from point "A" to point "B". Press once to select the starting point (A) press again to select the end point (B). Press a third time to stop the A-B Repeat.

Remote Control

19. EJECT button

Press to open or close the disc tray.

20. AUDIO button

Press to access various audio languages, when the DVD disc contains multiple audio languages.

21. 0-9 number buttons

Select numbers by pressing these buttons.

22. GOTO button

Press to select the desired disc starting Time, Track or Title.

23. +10 button

Select numbers greater than 9 by pressing the (+10) button first, and then additional number buttons as needed.

24. 16:9/4:3 button

Press to shift the aspect ratio between 16:9 and 4:3.

25. DVD SETUP button

Press to access the DVD setup menu under DVD mode.

26. INFO button

Press to display detailed playback information.

Press repeatedly to display additional information or to turn the information display OFF.

27. LCD ON/OFF button

Press to turn the LCD screen display on or off under TV, AV and DVD mode.

28. TIME button

Press it once to display the time on the display panel. In standby status, the time is still displayed on the display panel. Press it twice to set the time on the display panel. Use the ◀ ▶ buttons to select the editing position of hour or minute, use the ▲ ▼ buttons to adjust the value of the hour or minute upward and downward.

29. ⏭ NEXT button

Press to go to the next track under DVD mode.

30. ⏮ PREV button

Under DVD mode, press to go to beginning of current track or chapter. Press twice repeatedly to go to beginning of a previous track or chapter.

31. MUTE button

Press to turn on/off the speaker output. The corresponding information will be displayed on the display panel.

32. PAUSE button

Press to pause playback in DVD mode.

33. ZOOM button

Press to enter and cycle through zoom functions, use the direction buttons to pan around the screen.

34. VOL +/-

Press to increase or decrease the speaker volume level.

35. SLOW button

Press to activate slow forward playback.

System Connections

- ◆ Do not connect the power cord until all other connections have been made.
- ◆ Each time you restart the unit, it remembers the last function used.

Connecting To External AV Signal Source

Connections should be made as follows:

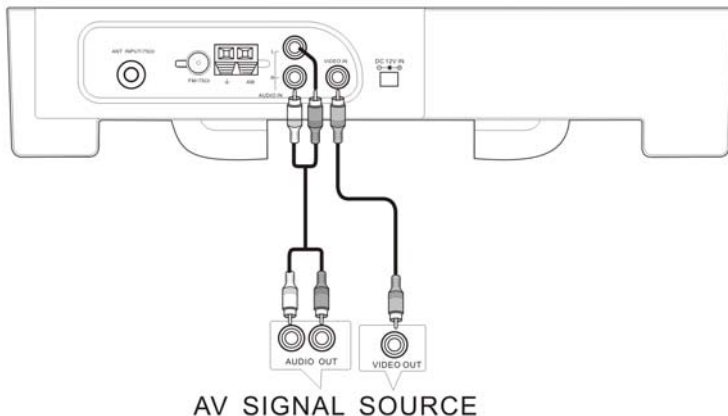

Connecting To TV Signal Input Source

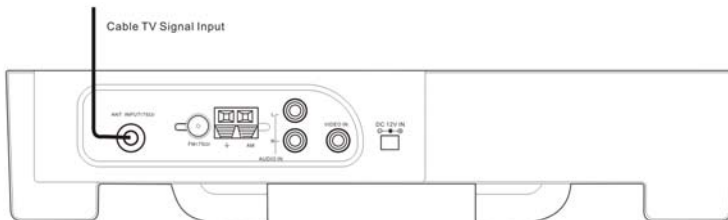

System Connections

Connecting To Antenna

Connect the supplied AM/FM antennas to listen to the radio.

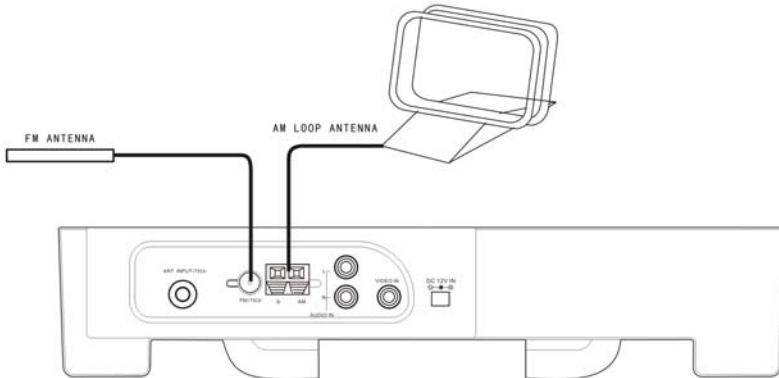

- ◆ In order to improve the signal, move AM loop antenna away from system and other equipment.
- ◆ Extend FM antenna fully.
- ◆ Keep the FM antenna as horizontal as possible after connection.
- ◆ When connecting the supplied AM loop antenna, connect two black cords to AM and ground jacks as shown below.

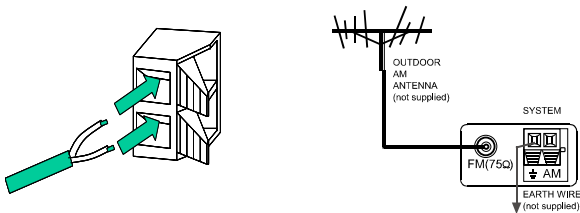

- ◆ If the FM reception is poor, use a 75 Ω coaxial cable (not supplied) to connect system to an outdoor FM antenna as above.
- ◆ If you connect the system with outdoor FM antenna, you should earth the system in order to avoid lightning strike.
- ◆ Do not connect the earth wire to gas pipe to prevent gas explosion.

System Connections

Connecting To the Power Adapter

This unit is powered via the switching power adapter (supplied). See the below figure for details:

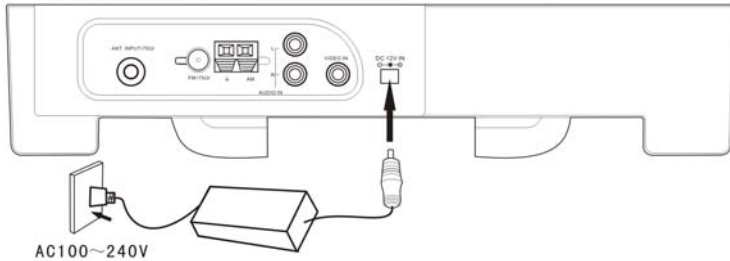

1. Connect the AC adapter to jack marked with “DC 12V IN” on the rear panel of the unit.
2. Plug the two-prong end of the power cord to the grounded electrical socket.
3. When not using the unit, turn off the power of the unit first, and then unplug the power supply to prevent malfunctions.

Radio Function

Radio Function Operation

Press the AM or FM button on the remote control or front panel to enter AM or FM radio mode. Then press the SEEK+/- button for about 1.5 seconds on the remote control or front panel to start searching forward/backward from the current frequency. Press the SEEK+/- button again to stop searching. Radio frequency will be displayed on the display panel. The frequency range of FM is from 87.5MHz to 107.9MHz, frequency range of AM is from 520kHz to 1710kHz.

Fine Tuning

Press the SEEK+/- button on the remote control or front panel once to fine tune the frequency forward/backward under radio mode.

Semi-memorizing radio stations

If you like a radio station and want to store it for later listening, press the SET button to memorize it. "SAVE X X" will be displayed on the display panel, "X X" represents the default station number.

There are two methods to organize the memorized stations:

- ◆ Use the ▲ ▼ buttons to adjust the channel number for your preference, and then press the SET button again, the station will be memorized with the coded station number.
- ◆ Press the SET button again, the station will be automatically memorized with the default station number in sequence.

You can store radio stations from 0 to 19, total 20FM or 20AM radio stations. If no buttons are pressed within 3 seconds of pressing the SET button first time, the frequency will appear on the display panel again, and the station will not be stored.

Accessing memorized radio stations

- ◆ Press the number buttons on the remote control to access a radio station by its memory location code.
- ◆ Press the ▲ ▼ buttons on the remote control or front panel to select the radio stations forward and backward.

When selecting the stations, the "CH XX" will appear on the display panel, where the "XX" is the channel number of the stored radio station. After a few seconds, the "CH XX" disappears and the radio frequency will be displayed once again.

TV Function

Basic Operation

Connect the antenna to the antenna jack on the rear panel. After connecting the antenna, connect the power supply cord. If the player is in standby mode, press the POWER button on the front panel to turn on the power.

Press the TV button on the remote control to shift to TV mode.

Press the ▲ ▼ buttons on the remote control, or use the number buttons directly, to select the desired channel.

Some preferences can be preset:

Picture Parameter Setup

Press the TV/LCD SETUP button once on the remote control to enter PICTURE setup menu, and screen display as shown:



Use the ▼、▲ buttons to select the item you want to set (Brightness, Contrast, Color).

Use the ▶, ◀ buttons to adjust, you can adjust the items between 0 and 20.

Use the ▼, ▲ buttons to select the Language, press the ▶, ◀ buttons to select English, French or Spanish.

To restore a setting to the original value, use the ▼、▲ buttons to select Reset, then press the OK button to confirm the change.

Press the ◀ button on the remote control to exit from the setup menu.

Press the ▶ button on the remote control to enter TV Setup menu.

TV System Setup

When the ▶ button is pressed, the TV system setup menu will appear:

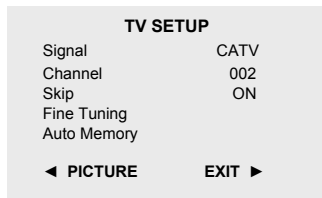

TV Function

Use the ▼、▲ buttons to select the item you want to set.

Use the ►、◄ buttons to select the item and enter it.

Press the ► button on the remote control to exit from the setup menu.

Press the ◄ button on the remote control to return to the picture setup menu.

Signal

Use the ► direction button to select CATV TV signal input mode.

Use the ◄ direction button to select AIR TV signal input mode.

Channel

Use the ►、◄ buttons to change the channel. In CATV input mode, you can select channels from 2 to 125; in AIR input mode, you can select channels from 2 to 69.

Skip

When the ► button is pressed to turn the function ON, it will skip the current channel when using ▼、▲ to select channels.

When the ◄ button is used to turn the function OFF, it will play the channels in sequence when selecting under normal playback status.

Fine Tuning

Use the ▼、▲ buttons to select Fine Tuning, and then press the ►、◄ buttons to tune forward or backward from the current channel

Auto Memory

Use the ▼、▲ buttons to select Auto Memory, press the OK button to enter auto memory mode:



TV Function

The auto memory will take a few minutes. The unit will search channels from the lowest channel to the highest channel in the standard channel list. When tuning operations are complete the unit will exit and store the channels by sequence in the memory.

During tuning, press the ◀ button to exit the auto memory.

Use the ▼、▲ direction buttons to select the desired channel from those in memory.

Timer Setup

Press the SET button on the remote control to enter Timer setup menu, the screen will display as below:

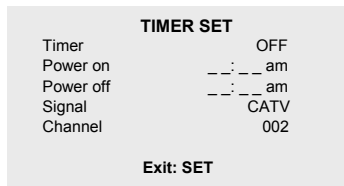

Use the ▼、▲ buttons to select the item you want to set.

Use the ▶, ◀ buttons to enter the item and to select.

Press the SET button again on the remote control to exit from the setup menu.

Timer

Use the ▶, ◀ direction buttons to select ON or OFF. This function allows you to set the start time and end time of the desired signal source. No matter what mode the unit is in, this function will automatically start the playback of the desired signal source.

Select ON to activate the function; select OFF to disable the function.

Power on

To set the playback start time of the signal source, use number buttons to input the desired start time in sequence of hour, minute. Press the ▶, ◀ direction buttons to shift between am and pm.

TV Function

Power off

To set the playback end time of the signal source, use number buttons to input the desired time in sequence of hour, minute. Press the ►, ◀ direction buttons to shift between am and pm. When the playback of the signal source is over, the player will enter standby mode.

Signal

Use the ►, ◀ direction buttons to select CATV, AIR, FM or AM.

Channel

Use number buttons to input the desired TV channels. In CATV signal input mode, there are 124 channels to choose from (2-125); in AIR signal input mode, there are 68 channels to choose from (2-69).

Press the ▲ ▼ buttons on the remote control to select the desired channel, or use the number buttons to input and then press the OK button to confirm.

Note:

The function is active as long as the unit is continuously supplied with power. The unit will automatically play the selected input signal at the set start time and enter standby mode at the set end time each day.

AV Function

AV Function

The player has an additional AV input so it can function as a monitor for a DVD player, video cassette player, satellite receiver, video game, etc. When an AV source is connected, press the AV button on the remote control to enter external input AV mode.

Picture Parameter Setup

Press the LCD SETUP button once on remote control to enter PICTURE setup menu, and screen will display as shown:



Use the ▼、▲ buttons to select the item you want to set (Brightness, Contrast, Color).

Use the ►、◀ buttons to adjust the items between 0 and 20.

Use the ▼、▲ buttons to select the Language, press the ►、◀ buttons to select English, French or Spanish.

Select Reset to return to the factory default settings.

Press the ◀ button on the remote control to exit from the setup menu.

Note:

Under AV mode, if there is no signal, the LCD screen will be turned off automatically.

When connected to an AV signal source, make sure the type of the selected AV signal source is NTSC.

Play Operation

Preparation

1. Install the unit in the kitchen; refer to page 32 for details.
2. After connecting the unit to the AC power, turn on the unit's power by pressing the POWER button on the front panel or the remote control.
3. Press the DVD button on the remote control or the SOURCE button to shift to DVD mode.
4. Press the EJECT button on the front panel or the remote control to open the disc tray.
5. Load the disc with the label facing up.
6. Press the EJECT button again to close the disc tray. The player will automatically search for the disc and start playback.

DVD Playback

Menu

Normally there is a selecting menu for DVD discs. You can press the MENU button to enter the menu, and use the direction buttons to highlight an item you would like to select. Press the OK button to select it.

Title & Chapter

Normally there are several titles in a DVD disc, and several chapters (sections) in a title. You can select any title or chapter quickly by entering the relevant number.

Audio

DVD discs can contain up to 8 audio bit streams. For Example: English, Spanish, French etc.

To select the audio bit stream you prefer press the AUDIO button on the remote control during playback. The DVD player will play the next audio bit stream every time you press the AUDIO button in succession.

Note: This function is only available for discs that have several audio bit streams recorded onto it.

Play Operation

Subtitle

A DVD disc can be recorded with up to 32 subtitles.

Press the SUBTITLE button on the remote control during playback to select the one you prefer.

NOTE: This function is only available on DVD discs that are recorded with multi-subtitles.

CD Playback

The player will play all tracks on a CD disc by default. You can use the ⏮ and ⏭ (PREV/NEXT skip) buttons, or number buttons to select a track.

MP3 playback

MP3 is an Audio compression format, which compresses the audio signal at the rate of 12:1. When using the MP3 format, one disc can record more than 600 minutes of music, with sound quality that is similar to that of CD discs.

There are many different methods for storing MP3 songs. Usually, one MP3 disc includes many folders (directories) and every folder includes several files (songs).

Load a MP3 formatted disc into the DVD Player and a menu will be displayed on the screen. In stop status, press the up/down direction button to select the directory as you desire and press the OK or PLAY button for confirmation, use the up/down direction buttons again to select the desired track. In playback status, use the ⏭ or ⏮ button to select the next or previous track.

- During MP3 playback, press the previous or next button to turn the page.
- There is no search by time or slow playback function for MP3 discs.

Play Operation

JPEG Playback

JPEG is a common picture format that requires small amounts of storage per image and has low loss in resolution. Hundreds of pictures can be stored on a disc in this format. In order to view JPEG photo albums, you can ask your film development company to make a "PICTURE CD" when they develop your film.

Normal Playback

Load a JPEG disc in. Use the OK button and Left/Right direction button to select a submenu with picture, and then use the Up/Down direction button to select the contents.

- **Many discs have other contents besides pictures.**

Picture Rotation

This can be used only when the picture is normally displayed. Once another picture is selected, rotation will be cancelled automatically.

During playback, use the direction buttons to rotate the picture.

Zoom and Move

The ZOOM button is used to turn on/off the zoom and move functions.

When this function is turned on, use the REV/FWD SCAN button to control zoom proportion and the TV screen will display the relevant proportion.

When this function is turned off, the picture will resume normal size. Press the MENU button to return to menu page.

- **Some JPEG discs may not support rotation or zooming functions.**

Playback Functions

Stop

During playback, press the STOP button once on the remote control to stop playback of a disc. Press the PLAY button and the DVD Player will resume playback of the disc from the point where it was stopped.

Pause

Press the PAUSE button once on remote control or front panel to pause playback. Press the PLAY button to resume normal playback.

Resume Playback

Press the STOP button at the point if you wish to stop the playback of a disc. The DVD Player will memorize the location where playback of the disc was stopped.

Press the PLAY button to resume normal playback. The DVD Player will resume the playback of the disc from the location where it was stopped. This function will not operate if the disc is removed from the DVD Player.

Press the STOP button twice (2). Playback of the disc will stop. When the PLAY button is pressed again, playback of the disc will start from the beginning of disc.

Zoom

Press the ZOOM button on the remote control to cycle through the different zoom settings.

Fast Playback

Press the ◀ or ▶ button on the remote control to activate fast forward or rewind playback.

Slow Playback

Press the SLOW button to activate slow forward playback.

◆ There is no slow playback for MP3, CD discs.

Search By Time

During DVD disc playback, press the GOTO button on the remote control once, there will be a menu displayed on the screen. You can set or select items for your preference.

Use the ▲ ▼ direction buttons to select items, press the OK button to enter and use the ▲ ▼ direction buttons to select the desired item. Press the ◀ direction button to return.

When select the Title or Chapter, use number buttons to input desired title or chapter.

◆ Some DVD discs do not support the search function.

Playback Functions

Previous and Next

Press the PREV ⏮ button once to return to the currently playing Chapter or Track. Press the PREV button twice repeatedly and playback will start from the previous Chapter or Track.

Press the NEXT ⏭ button on the remote control and playback of the disc will start from the next Chapter or Track.

Repeat

To repeat a Title, Chapter or Track press the REP button on the remote control. Continually pressing the REP button will display a menu as follows: Repeat Chapter, Title, All.

You can temporarily select a section of a DVD that you would like to play repeatedly. You do this by marking the start and the end of the section using the A/B button. During playback press the A-B button on the remote control at the beginning of the segment (point A) you wish to play repeatedly. Press the A-B button again to mark the end of the segment (point B).

The DVD player will automatically return to point A and repeat playback of the selected segment (A-B). To resume normal playback, press the A-B button again.

Screen Mode

Press the 16:9/4:3 button on the remote control to switch the screen aspect ratio between 16:9 and 4:3.

System Setup

DVD Setup

You can customize the set up menu to your own preference.

Press the "DVD SETUP" button on the remote control to display the setup menu. The menu will include "General Setup", "Speaker Setup", "Dolby Digital Setup", "Video Setup", and "Preference Setup". Press the direction button (◀ ▶ ▲ ▼) on the remote control to select a category. All the items in the category will appear on the screen. Press the "OK" button to enter the category.

Category

When you enter a category all the items under this category will appear, the highlighted category is the current set up.

Press the right direction button (▶) on the remote control to select another category (new selection will be highlighted). Press the "OK" button for confirmation.

Press the left direction button (◀) to enter the other setup menu(s).

General Setup

TV Display

Select Normal/PS or Normal/LB when a 4:3 TV is connected.

Select Wide when a 16:9 when using the screen on the unit or when a wide screen TV is connected to the video output.

OSD Lang

There are three different OSD languages for selection. You can select English, French or Spanish.

Captions

You can choose captions ON or OFF during playback.

Screen Saver

When activated, under stop mode, the unit will go into screen saver mode if the same image remains on the screen for several minutes, and then enter standby mode automatically.

System Setup

Speaker Setup

Downmix

Select "LT/RT" in DOWNMIX, the player will output the audio signal IN MIXED MONO. Select "Stereo", then the player will output a stereo signal.

Dolby Digital Setup

Dual Mono

The function is used to select from stereo, left only, right only, and mixed mono.

Dynamic

Use this item to adjust linear dynamic compression rate to get different signal compression effects.

Video Setup

Sharpness

Use this setting to adjust the sharpness level

Brightness

Use this setting to adjust the brightness level.

Contrast

Use this setting to adjust the contrast level.

Preference Page

Audio, Subtitle, Disc Menu

This setting allows you to hear or read the subtitles of a DVD in your choice of English, Spanish and French etc. if the disc contains multiple languages.

Parental

DVD discs equipped with the child lock function are rated according to their contents and settings vary from disc to disc. Depending on the disc, you can lock out selected scenes or playback of the disc altogether. Access parental control by pressing the ▲ ▼ (direction buttons) on the remote control and then press the OK button.

System Setup

Password

Parental control features are password protected. The original setting is unlocked. This setting allows you to use number buttons to input any password.

Note: The Default Password is 1369. This password is always effective even after you have selected your own password and changed it. To avoid the possibility of others using the default password to set the parental level and change the password, you can record this default password in another area and delete it from this manual. Some discs can be limited depending on the age of users while some discs cannot.

Default Reset

Use this function to reset all the settings.

Note: For preference setting, the unit must be in the stop mode.

LCD Setup

Under DVD mode, press the LCD SETUP button on the remote control or front panel, there will be menu displayed on the screen.



Use the ▼、▲ buttons to select the item you want to set (Brightness, Contrast, Color).

Use the ►, ◀ buttons to adjust, you can adjust the items between 0 and 20.

Use the ▼, ▲ buttons to select the Language, press the ►, ◀ buttons to select English, French or Spanish.

Select Reset to resume the original status.

Press the ◀ button on the remote control to exit from the setup menu.

Installing the Unit In Kitchen

Installing the unit under a cabinet

The player unit may be installed in the kitchen with or without the spacer. The suggested mounting position of the unit is under a wall cabinet. See drawings below:

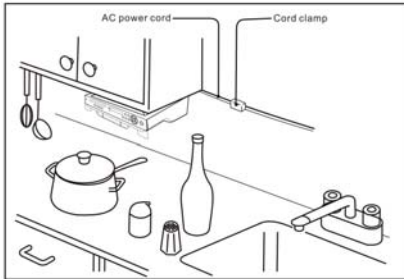

NOTE: The dimensions of the player: 355mm x 75mm x 285 mm (W/H/D)

There should be at least 35mm distance between the unit and the wall.

Installing steps

1. Mark the position of the 4 holes by using the supplied template. Drill four 6.5 mm diameter holes. As shown below:

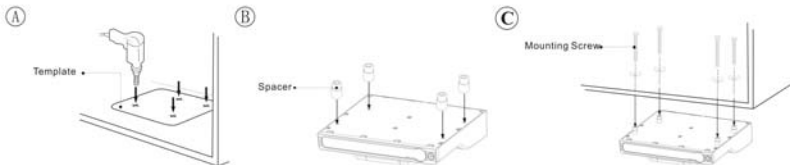

Installing the Unit in Kitchen

2. If the cabinet door overhangs the shelf and obstructs the unit, adjust the unit or the shelf height for clearance.
3. Install the unit with the supplied mounting screws.
4. There should be at least 35mm distance between the unit and the wall.

Quick hints

- ◆ Since the unit is rather heavy, be careful while doing the fixing work.
- ◆ To reduce risk of fire, do not place any heating or cooking appliance beneath the unit, especially while the LCD screen is open on viewing.
- ◆ Mount the unit so that its AC power cord can be plugged directly to a wall outlet. Do not use a converter or extension cord.
- ◆ Be sure that the AC power cord has no slack when the player is working, because the cord acts as an FM wire antenna. If the AC power cord has some slack, wind it up to the cord hook until the cord has no slack.
- ◆ The unit has a built-in ferrite bar antenna for AM radio reception. Check the condition of AM reception before fixing in position.
- ◆ Install the unit as far as possible from a source of noise, for example, refrigerator, microwave oven, fluorescent lamp, etc.

Troubleshooting

SYMPTOM	CHECK ITEM
The player cannot play.	Make sure a disc is loaded. Make sure the disc is loaded with label side up. Disc should be clean, not dirty or warped. Player's region code should be the same as the region code of the DVD disc. Make sure water condensation has not occurred. If it has, remove the disc and keep the player power on until the moisture evaporates.
There is no sound.	Make sure system connection is correct. Make sure the player is not under muting mode. Press the MUTE button to turn on the speaker. Make sure the volume is adjusted to the lowest. Adjust the volume upward. Is your disc dirty or warped? Clean or replace it.
There is no picture or picture is unsteady. Position of the picture is incorrect.	Make sure the video type of the AV signal source TV is NTSC. Make sure system connection is correct. Is your disc dirty or warped? Clean or replace it.
Cannot continue to play and plays a section repeatedly.	Make sure the player is not in A-B repeat status. Press A-B button to cancel A-B repeat status. Is your disc dirty or warped? Clean or replace it.
The remote control does not work.	Make sure there are no obstructions between the remote control and the player. Make sure the remote control is pointing at the player. Make sure batteries are inserted correctly (check polarity). Replace weak batteries.

Other Notes: Static or other external interfere may cause the player to behave abnormally. If this occurs, unplug the power-supply cord from the outlet and plug it in again to reset the player. If the problems persist, then please disconnect the power and consult a qualified technician.

Specifications

LCD screen size		7 inches	
Laser Wavelength		Wavelength: 780/650nm	
Video System		NTSC	
Frequency Response		20Hz~20kHz \pm 2.5dB	
Audio Signal-to-Noise		\geq 85 dB	
Audio distortion + noise		\leq -70dB (1KHz)	
Channel Separation		\geq 70dB (1KHz)	
Dynamic Range		\geq 80dB (1KHz)	
Radio	System		PLL
	Frequency Range	AM	520~1710kHz
		FM	87.5~107.9MHz
Power		AC100V~ 240V, 50/60Hz	
Power Consumption		<25W	
Dimension		355mm X 75mm x 285mm (W/H/D)	
Weight		About 4 kg	

DESIGN AND SPECIFICATIONS ARE SUBJECT TO CHANGE WITHOUT NOTICE

Manufactured under license from Dolby Laboratories.

“Dolby” and the double-D symbol are trademarks of Dolby Laboratories.

Confidential unpublished works. © 1992 -1997 Dolby Laboratories.

All rights reserved.

For service, support and warranty information, visit www.polaroidelectronics.com or in the US call 1-866-289-5168, in Canada call 1-866-301-7922 and in Mexico call 01-800-400-2443.

“Polaroid” is a registered trademark of Polaroid Corporation of Waltham, MA USA and licensed for use on the FDM-0700A to Petters Consumer Brands, LLC.